

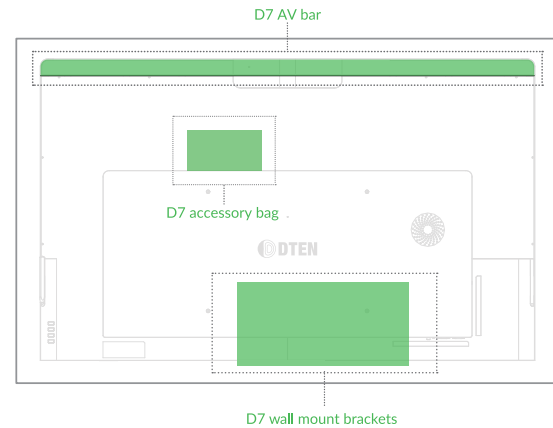

# D7 55" Dual Product Guide

## What's Inside

1. DTEN D7 55" (Main Display) x 1
2. DTEN D7 55" (Secondary Display) x 1
3. DTEN Stylus x1
4. 2-in-1 Y-shaped Power Cable x1
5. RS232 to USB Adapter x1
6. USB+HDMI 2-in-1 Cable x1



### Installation Tip:

Mounting hardware and installation guides are supplied with each DTEN D7.

⚠ Do not disassemble DTEN products without the supervision or guidance of a DTEN technician. Failure to do so will void product warranty.

## D7 55" Dual Installation Diagram

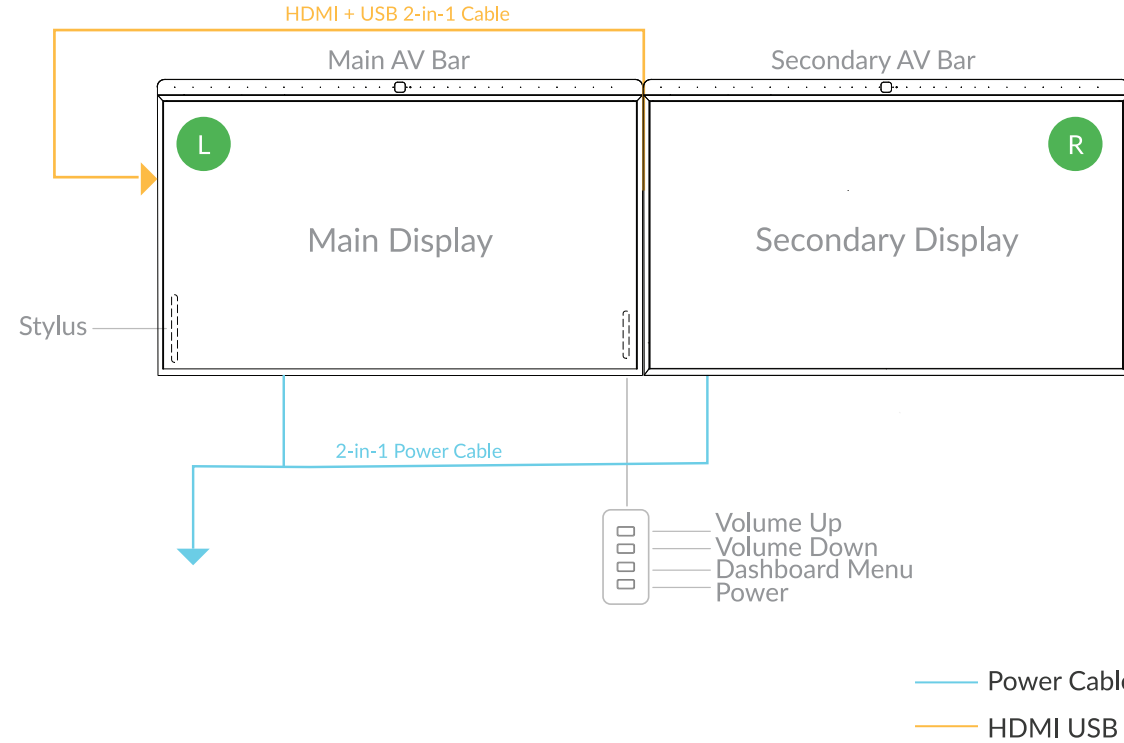

## Quick Setup

### STEP 1

Setup the two DTEN D7s side-by-side. The D7 on the left will be Main Display (L), and the D7 on the right will be Secondary Display (R).

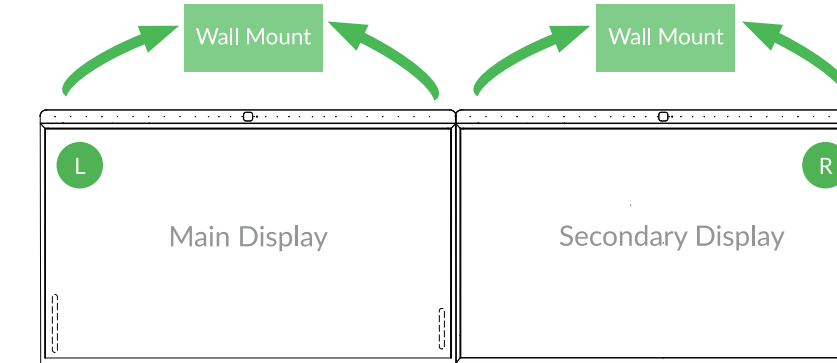

### STEP 2

Connect the Main Display to the Secondary Display with provided HDMI+ USB 2-in-1 cable.

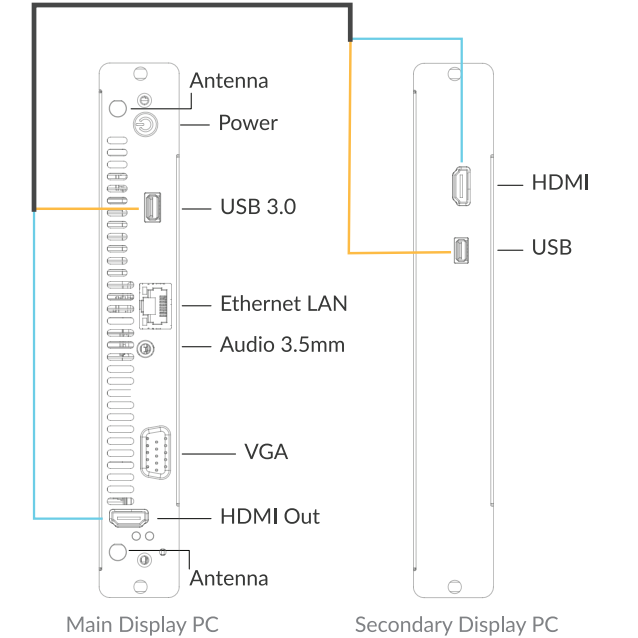

## Quick Setup

### STEP 3

Attach both AV bars on each display and connect the Y-shaped power cable to both displays. The displays will power on by themselves.

Follow the instructions on-screen to set up the network.

Tip: Ethernet connection is preferred for the best meeting experience.

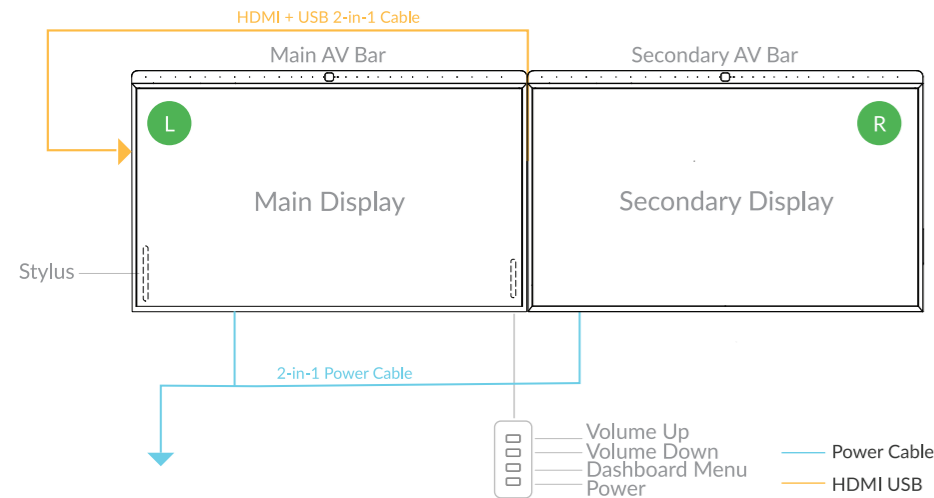

## Zoom Rooms Setup

**STEP 1** You will need an active Zoom account\* to sign in.

**STEP 2** Select an existing room or create a new room.

\* Visit [zoom.us](https://zoom.us) for more information.

### Tips

1. Increase the volume to the max using the volume button (the first button at the back).
2. Ethernet connection is preferred for the best meeting experience.
3. To pair with the zoom rooms controller, please visit [zoom.us](https://zoom.us).
4. Please do not disconnect the power without properly shutting down the system.
5. Do not disassemble the DTEN product without the supervision of a DTEN technician.

If you have any questions, feel free to contact us.

✉ [support@dten.com](mailto:support@dten.com) ☎ +1.866. 936.3836

## Main Display Port Diagrams

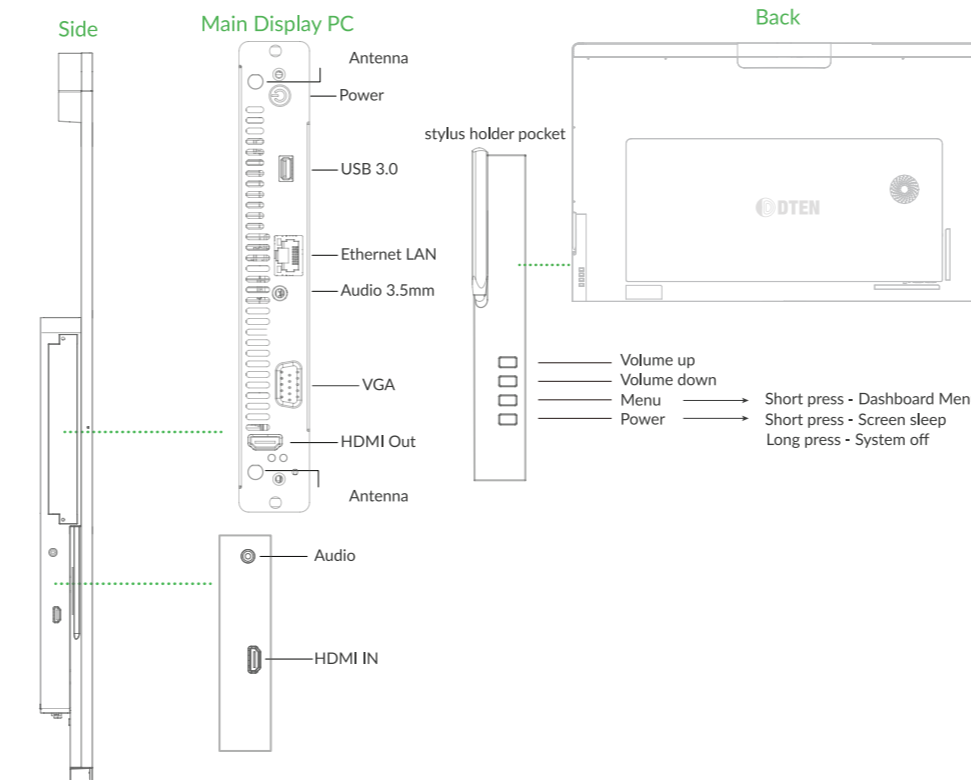

## Secondary Display Port Diagrams

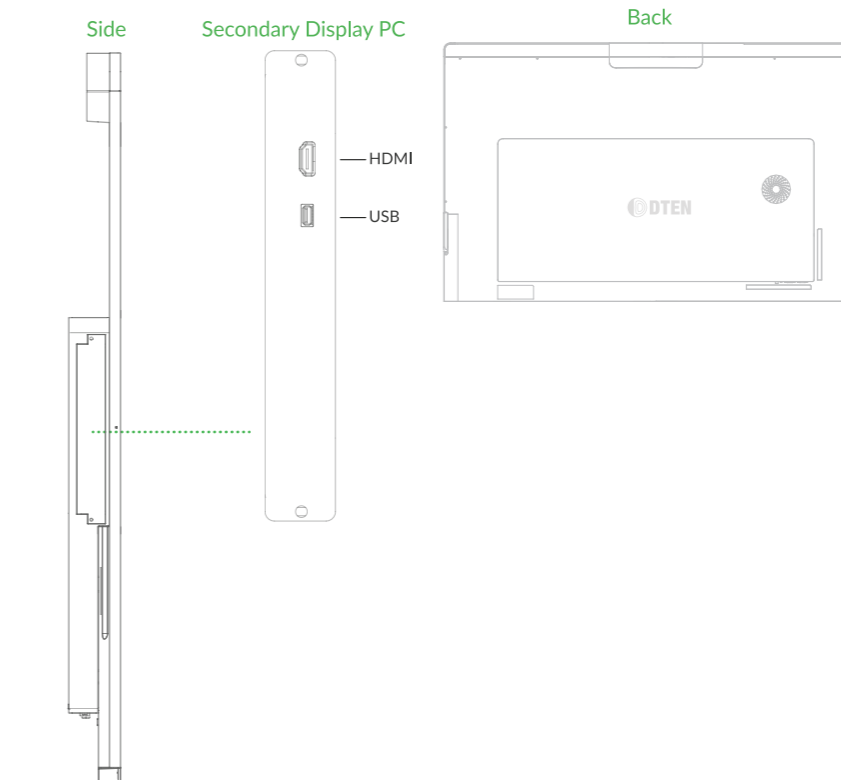

## Wall Mount

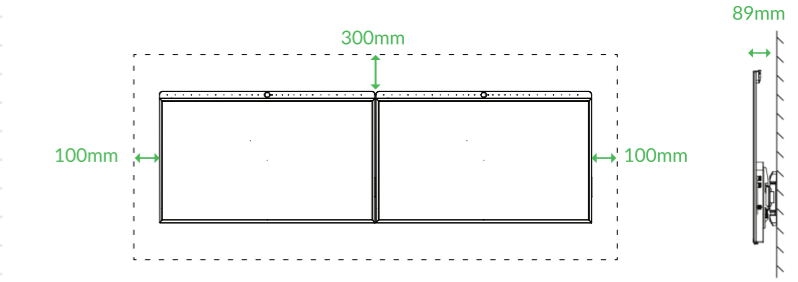

Mounting Hole Pattern: 400 x 300mm

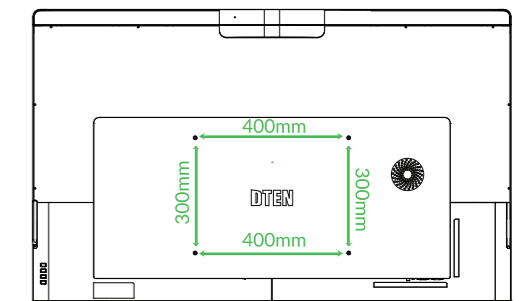

⚠ Note: Contact a professional for assistance when wall mounting your display. We are not responsible for any damage to the product or injury to yourself. Do not power on the display when performing wall mount installation. It may cause personal injury due to electric shock.